

# Maple Leaf WHEELCHAIR





## PARTS CATALOGUE

### Cross Brace



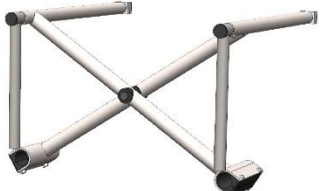

6540 Tomken Road  
Mississauga ON L5T 2E9  
905.564.2250  
905.564.5424  
1.800.362.0873  
[www.mapleleafwheelchair.ca](http://www.mapleleafwheelchair.ca)

# Cross Brace



Part No.	Part Name	Part Description	Cost	
CRB1	Cross Brace Type 1 Complete Assembly	Complete cross brace set for NRG+, Swift, Access, and NRG+ Recliner. (14"-18" seat width)	320/ each	
CRB2	Cross Brace Type 1 Upsized Complete Assembly	Complete upsized cross brace set for NRG+, Swift, Access, and NRG+ Recliner. (19"-20" seat width)	400/ each	
CRB3	Cross Brace Type 2 Complete Assembly	Complete cross brace set for NRG+ Gold and EZ Ride. (14"-18" seat width)	420/ each	
CRB4	Cross Brace Type 2 Upsized Complete Assembly	Complete upsized cross brace set for NRG+ Gold and EZ Ride. (19"-20" seat width)	500/ each	
CM13	Cross Brace Type 3 Complete Assembly	Complete double cross brace set for HD wheelchair models. (20"-24" seat width)	560/ each	
CRB6	Cross Brace Type 3 Upsized Complete Assembly	Complete double upsized cross brace set for HD wheelchair models. (Greater than 24" seat width)	640/ each	
CRB7	Cross Brace Type 4 Complete Assembly	Complete cross brace set for Escape Commode models. (16"/18" seat width)	420/ each	
CRB8	Cross Brace Type 4 Custom Complete Assembly	Complete custom cross brace set for Escape Commode models. (Custom Frame)	520/ each	

(All Images are for Visual reference please use the Part Description for determining the correct required part.)  
Maple Leaf Wheelchair © 2021

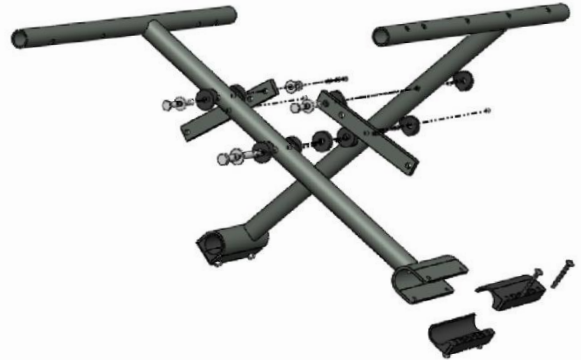

CX001	Cross Brace Type 1 R	Right side cross brace for NRG+, Swift, Access, and NRG+ Recliner. (14"-18" seat width)	120/ each	
CX002	Cross Brace Type 1 L	Left side cross brace for NRG+, Swift, Access, and NRG+ Recliner. (14"-18" seat width)	120/ each	
CX003	Cross Brace Type 1 R (Upsized)	Right side Upsized cross brace for NRG+, Swift, Access, and NRG+ Recliner. (19"-20" seat width)	160/ each	
CX004	Cross Brace Type 1 L (Upsized)	Left side Upsized cross brace for NRG+, Swift, Access, and NRG+ Recliner. (19"-20" seat width)	160/ each	
CX100	Cross Brace Sleeve Type 1	Sleeve for attaching rotating side of cross brace to wheelchair for NRG+, Swift, Access, and NRG+ Recliner.  (Circular sleeve goes inside the tubing)	60/ each	



CX005	Cross Brace Type 2 R	Right side cross brace for NRG+ Gold and EZ Ride. (14"-18" seat width)	180/ each	
CX006	Cross Brace Type 2 L	Left side cross brace for NRG+ Gold and EZ Ride. (14"-18" seat width)	180/ each	
CX007	Cross Brace Type 2 R (Upsized)	Right side Upsized cross brace for NRG+ Gold and EZ Ride. (19"-20" seat width)	220/ each	
CX008	Cross Brace Type 2 L (Upsized)	Left side Upsized cross brace for NRG+ Gold and EZ Ride. (19"-20" seat width)	220/ each	
CRB010	Cross Brace Sleeve Type 2	Sleeve for attaching rotating side of cross brace to wheelchair for NRG+ Gold, EZ Ride.  (Plastic sleeve goes over tubing)	40/ set	





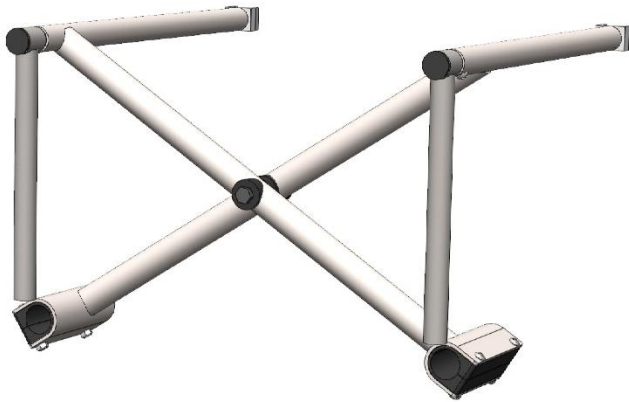

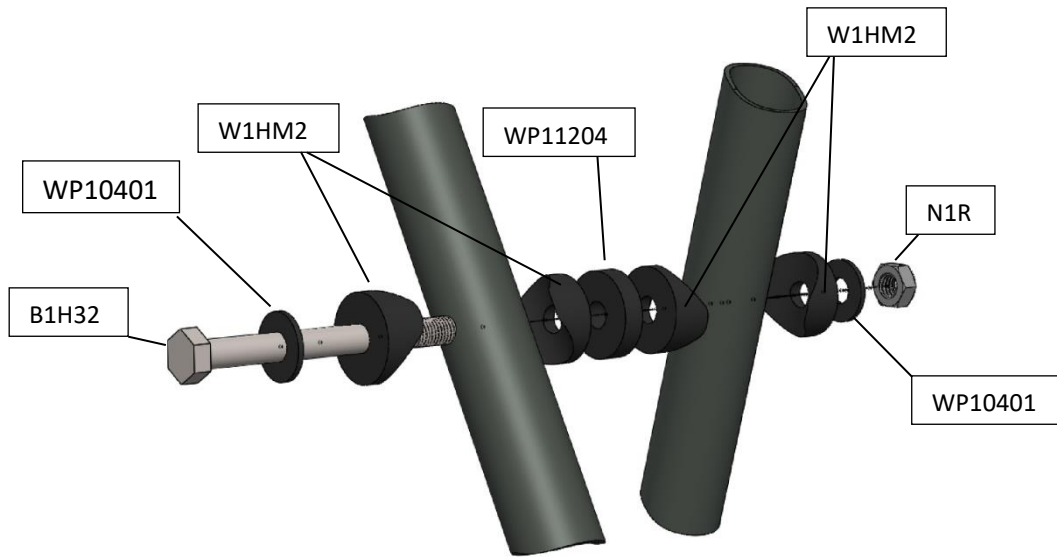

CX001-D	Cross Brace Type 3 R	Right side Double cross brace for HD wheelchair models. (20"-24"seat width)	240/ each	
CX002-D	Cross Brace Type 3 L	Left side Double cross brace for HD wheelchair models. (20"-24"seat width)	240/ each	
CX003-D	Cross Brace Type 3 R (Upsized)	Right side Upsized Double cross brace for HD wheelchair models. (Greater than 24"seat width)	280/ each	
CX004-D	Cross Brace Type 3 L (Upsized)	Left side Upsized Double cross brace for HD wheelchair models. (Greater than 24"seat width)	280/ each	
CRB015	Cross Brace Sleeve Type 3	Sleeve for attaching rotating side of cross brace to wheelchair for HD wheelchair models.  (Circular sleeve goes inside the tubing)	60/ each	





CRB016	Cross Brace Type 4 R	Right side cross brace for Escape Commode models. (16"/18" seat width)	160/ each	
CRB017	Cross Brace Type 4 L	Left side cross brace for Escape Commode models. (16"/18" seat width)	160/ each	
CRB018	Cross Brace Type 4 R  (Custom)	Right Side Upsized cross brace for Escape Commode models. (Custom Frame)	200/ each	
CRB019	Cross Brace Type 4 L  (Custom)	Left Side Upsized cross brace for Escape Commode models. (Custom Frame)	200/ each	
CRB020	Escape Commode Pivot Sleeve	Sleeve that allows Escape commode to pivot and fold.	80/ each	



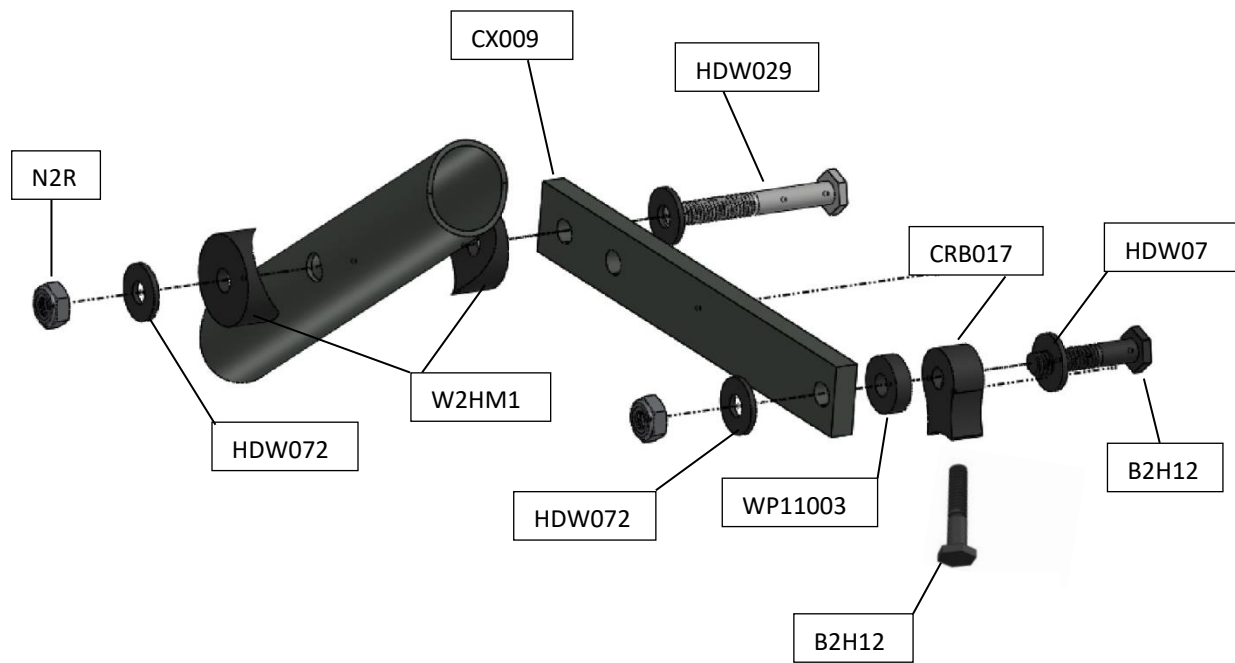







N1R	5/16" Stover Nut	Nut that secures all 5/16" Bolts in the Cross-brace section.	0.50/ each	
B1H32	5/16" x 3 1/4" Hex Cap Bolt	Connects the Left and Right Cross.	1/ each	
WP10401	5/16" x 3/4" O.D. x 0.0625"T	Washer that goes with nut that secures all 1/4" Bolts.	1/ each	
WP11204	5/16" x 1" O.D. x 1/4"T Washer	Washer that goes between left and right cross brace sits on face of HDW053.	1/ each	
W1HM2	5/16" x 7/8" O.D Radius Half-moon Washers	Half-moon washer that sits on either side of tubing where cross brace intersects.	2/ each	
HDW070	1/4" x 1/2" O.D x 1/16"T Curved Washer	Curved washer used instead of 1/4" Half-moon washer in the HD Double Cross brace.	1/ each	



CX009	Cross Brace Links	Cross Brace links for securing cross brace to side frame. (Size and wheelchair model need to be specified)	15/ each	
CRB017	Cross Link Mounting Bracket	Bracket that attaches the cross link to the side frame for support. (Used in the NRG + Gold, EZ Ride)	5/ each	
SF627	Rear Saddle Bracket (Pillow Block)	Bracket that supports the Cross brace to the side frame along the frame.	15/ each	



B2H16H	1/4" x 1 3/4" Socket Head Screw	Socket Head Screw for attaching Mounting Bracket to Frame.	1/ each	
B2H12	1/4" x 1 1/4" Hex Cap Bolt	Hex Cap Bolt to attach brace links to Mounting Bracket/Frame.	1/ each	
HDW029	1/4" x 2" Hex Cap Bolt	Hex Cap Bolt attach brace link to Cross-brace.	1/ each	
N2R	1/4" Stover Nut (Coarse Thread)	Nut that secures all 1/4" Bolts in the Cross-brace section.	0.50/ each	
HDW072	1/4" x 5/8" O.D x 1/16"T Steel Washer	Washer that goes with nut that secures all 1/4" Bolts.	1/ each	

WP11003	1/4" x 5/8" O.D. x 3/16"T Plastic Washer	Washer that goes between Cross brace links	1/ each	
W2HM1	1/4" x 7/8" O.D Radius Half- moon Washers	Half-moon washer that sits between Cross brace link and the Cross brace	2/ each	
BB003	Bottom Rail Bushing	Bushing on the wheelchair where the bottom rail and the cross-rail meet.	5/ each	
BB022	Escape Commode Translating Bushing	Bushing that fixes the cross brace to the frame that translates as the chair is folded.	5/ each	
BB019	Escape Commode Pivot	Escape Commode cross brace bushing that allows the pivot sleeve (CRB020) to rotate and pivot on it.	10/ each	