

# Maple Leaf WHEELCHAIR





## PARTS CATALOGUE 2026 WHEEL ASSEMBLY





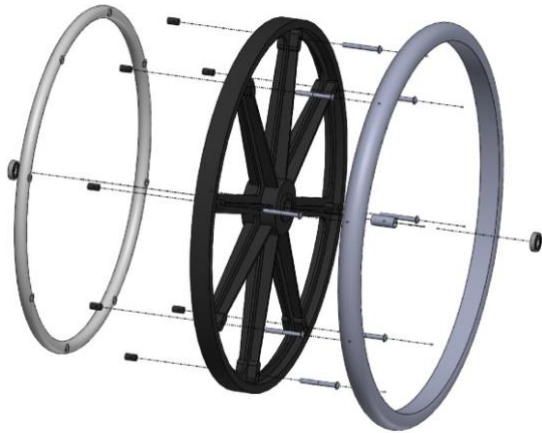

6540 Tomken Road  
Mississauga ON L5T 2E9  
905.564.2250  
905.564.5424  
1.800.362.0873  
[www.mapleleafwheelchair.ca](http://www.mapleleafwheelchair.ca)



# Wheel Assembly



Part No.	Part Name	Part Description	Cost	
W24A138U	24 Inch Mag Wheel Assembly	Mag Wheel Assembly. (Dia24" w 1 3/8"; Threaded Urethane Tire)	220/ each	
W22A138U	22 Inch Mag Wheel Assembly	Mag Wheel Assembly. (Dia22" w 1 3/8"; Threaded Urethane Tire)		
W20A138U	20 Inch Mag Wheel Assembly	Mag Wheel Assembly. (Dia20" w 1 3/8"; Threaded Urethane Tire)		
SW24	24 Inch Spoke Wheel Assembly	Spoke Wheel Assembly. (Dia24" w 1 3/8"; Threaded Urethane Tire)	220/ each	
SW22	22 Inch Spoke Wheel Assembly	Spoke Wheel Assembly. (Dia22" w 1 3/8"; Threaded Urethane Tire)		
SW20	20 Inch Spoke Wheel Assembly	Spoke Wheel Assembly. (Dia20" w 1 3/8"; Threaded Urethane Tire)		

W24H	24" Mag Wheel	24" Mag wheel. (Wheel only no tire included)	150/ each	
W22H	22" Mag Wheel	22" Mag wheel. (Wheel only no tire included)		
W20H	20" Mag Wheel	20" Mag wheel. (Wheel only no tire included)		
W24TU	24" Tubeless Tire	Tubeless Urethane Tire Dia24" width 1 3/8".	60/ each	
W22TU	22" Tubeless Tire	Tubeless Urethane Tire Dia22" width 1 3/8".		
W20TU	20" Tubeless Tire	Tubeless Urethane Tire Dia20" width 1 3/8".		
W24SSH	24" Mag Hand Rim (Chrome)	Chrome Hand Rim for 24" Wheels for Mag wheels. (Steel)	70/ each	
W22SSH	22" Mag Hand Rim (Chrome)	Chrome Hand Rim for 22" Wheels for Mag wheels. (Steel)		
W20SSH	20" Mag Hand Rim (Chrome)	Chrome Hand Rim for 20" Wheels for Mag wheels. (Steel)		
W24CH	24" Spoke Hand Rim (Chrome)	Chrome Hand Rim for 24" Wheels for Spoke wheels. (Aluminum)	70/ each	
W22CH	22" Spoke Hand Rim (Chrome)	Chrome Hand Rim for 22" Wheels for Spoke wheels. (Aluminum)		
W20CH	20" Spoke Hand Rim (Chrome)	Chrome Hand Rim for 20" Wheels for Spoke wheels. (Aluminum)		





W24PCH	24" Mag Hand Rim (Plastic Coated)	Plastic Coated Hand Rim for 24" Wheels for Mag wheels. (Steel)	90/ each	
W22PCH	22" Mag Hand Rim (Plastic Coated)	Plastic Coated Hand Rim for 22" Wheels for Mag wheels. (Steel)		
W20PCH	20" Mag Hand Rim (Plastic Coated)	Plastic Coated Hand Rim for 20" Wheels for Mag wheels. (Steel)		
W24PHR	24" Spoke Hand Rim (Plastic Coated)	Plastic Coated Hand Rim for 24" Wheels for Spoke wheels. (Aluminum)	90/ each	
W22PHR	22" Spoke Hand Rim (Plastic Coated)	Plastic Coated Hand Rim for 22" Wheels for Spoke wheels. (Aluminum)		
W20PHR	20" Spoke Hand Rim (Plastic Coated)	Plastic Coated Hand Rim for 20" Wheels for Spoke wheels. (Aluminum)		
ADD-P	Hand Rim Projection Add-on	Hand Rim Projection Add-on. (Hand rim with custom projection for assisted movement can be ordered upon request. ADD "P" to the end of existing part numbers to order.)  (Example. To order 24" Mag Hand Rim [WA2408] with projection part number to order would be W2408P)	+40/ each	Add-On
WL1HS	Hand Rim Spacers Set (Mag Wheel)	Set of 8 Hand Rim Spacers for 20"/22"/24" for Mag Wheels Hand Rims measured #10x 5/8"L. (Sold as set of eight)	8/ Set	
WA002	Hand Rim Spacers Set (Spoke Wheel)	Set of 8 Hand Rim Spacers for 20"/22"/24" for Spoke Wheels Hand Rims measured #10x 1"L. (Sold as set of eight)		



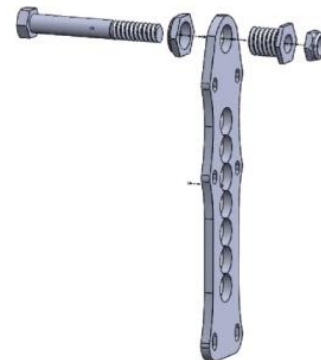

W3HSM	Hand Rim Screw Set  (Spoke Wheel)	#10-32 I.D x 2 1/4" Long Round Cap Phillips Screw.  (Spoke Hand Rims Screw)	16/ Set	
W2HSC	Hand Rim Screw Set  (Mag Wheel)	#10-32 I.D x 1 1/2" Long Round Cap Phillips Screw.  (Mag Hand Rim Screw)		
PPG015	Wheel Hub Cap	Hub Cap for the 20"/22"/24" Mag wheel.	5/ each	
PPG050	Wheel Hub Cap	Hub Cap for the 20"/22"/24" Spoke wheel.	2/ each	





Quick Release Mechanism

Regular Rear Axle and Nut

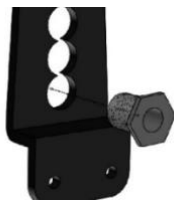

W006APER	Axle Plate Type 1  Super tilt	Rear Wheel Axle Plate used in the Super Tilt wheelchair model.	60/ each	
W005APSW	Axle Plate Type 2  Swift Low Rider	Rear Wheel Axle Plate used in the Swift and Low Rider wheelchair models.	60/ each	
W001APEG	Axle Plate Type 3  NRG+ Gold EZ Ride	Rear Wheel Axle Plate in the NRG+ Gold and EZ Ride wheelchair models.	60/ each	
W202224 QR	Quick Release Type 1	Quick release Axle measured 1/2"D x 4.5" Long.  (Used in the NRG+ Gold, EZ ride and Swift wheelchair models.)	90/ each	
W202224 QR3	Quick Release Axle type 2	Quick release Axle measured 7/16"D x 4.5" Long.  (Used in the Access, NRG+ and NRG+ Recline wheelchair models.)	90/ each	
W202224 RA1	Rear Axle type 1	Rear Axle Measured 1/2"D x 3 1/4" Long. (Used in Low Rider wheelchair model)	10/ each	

W202224 RA2	Rear Axle type 2	Rear Axle Measured 1/2"D x 3 1/2" Long. (Used in Super Tilt wheelchair model)		
W202224 RA3	Rear Axle type 3	Rear Axle Measured 1/2"D x 5" Long. (Used in NRG+ Gold, EZ Ride, Swift and Geriatric wheelchair models.)  Sold with [HDW001]	15/ each	
W202224 RA6	Rear Axle and Nut type 4	Rear Axle and Nut Measured 7/16"D x 4 1/2" Long. (Used in Access, NRG+, NRG+ Recline and Commode wheelchair models.)  Sold with [HDW003]		
HDW001	Rear Axle Nut 1/2"	Rear Axle Nylon Lock Jam Nut Measuring 1/2-13 coarse thread. (Used in Type 1, 2 & 3 Rear Axles)	3/ each	
HDW003	Rear Axle Nut 7/16"	Rear Axle Stover Nut Measuring 7/16-16 fine thread. (Used in Type 4 Rear Axles)		
W007AR	Axle Receiver Type 1	Axle Receiver for the NRG+ Gold, EZ Ride and Swift wheelchair models. (2 1/8" Long). used for standard and quick release axles. (Requires two Receiver Nuts to lock)	10/ each	
W002ARDT	Axle Receiver Type 2	Axle Receiver for the Low Rider (7/8" Long). (Requires one Receiver Nuts to lock)		

W001ARST	Axle Receiver Type 3	Axle Receiver for the Super Tilt (1 1/8" Long). (Requires one Receiver Nuts to lock)	25/ each	
W002ARRE	Axle Receiver Type 4	Axle Receiver for the Super Tilt (1 5/16" Long). (Requires one Receiver Nuts to lock)  [used with the last hole of the Super Tilt Axle Plate type 1 (WAS11) as shown in pic]		
W001ARNL	Thin Axle Receiver Lock Jam Nut	Thin Axle Receiver Nylon Lock Jam Nut. (Used in Super Tilt and Low Rider wheelchairs) (3/4 - 16 Nylon Lock Jam Nut)	4/ each	
W001ARNEG	Axle Receiver Jam Nut	Regular Axle Receiver Jam Nut. (Used in all other wheelchairs) (3/4 - 20 Jam Nut)	3.75/ each	
W202224BR2	28mm x 1/2" Rear Wheel Bearing	Ball Bearing for Rear Wheel Assembly used in 20"/22"/24" having a 28mm O.D and 1/2" I.D. used for spoke wheels. (Used in NRG+ Gold, EZ Ride, Swift, Super Tilt and Low Rider Models models)	10/ each	

BB031	28mm x 7/16" Rear Wheel Bearing	Ball Bearing for Rear Wheel Assembly used in 20"/22"/24" having a 28mm O.D and 7/16" I.D. used for spoke wheels. (Used in Access, NRG+, NRG+ Recline models)		
W202224 BR1	1 1/8" x 1/2" Rear Wheel Bearing	Ball Bearing for Rear Wheel Assembly used in 20"/22"/24" having a 1 1/8" O.D and 1/2" I.D. used for Mag wheels. (Used in NRG+ Gold, EZ Ride, Swift, Super Tilt and Low Rider Models models)	10/ each	
W202224 BR3	1 1/8" x 7/16" Rear Wheel Bearing	Ball Bearing for Rear Wheel Assembly used in 20"/22"/24" having a 1 1/8" O.D and 7/16" I.D. used for Mag wheels. (Used in Access, NRG+, NRG+ Recline models)		